

**Mini-PLC STG-600
Art. No. 0850-0600**

MANUAL

TABLE OF CONTENT

1	SAFETY INSTRUCTIONS	2
2	DESTINATED USE	2
3	DISCLAIMER	2
4	PRODUCT DESCRIPTION	2
4.1	Features	2
4.2	Applications	2
4.3	General description	2
4.4	Programming with miCon-L	3
4.5	Delivery content	3
5	INSTALLATION	3
5.1	Mounting	3
5.2	Wiring	3
5.2.1	Connecting the power supply	3
5.2.2	Connecting the inputs	4
5.2.3	Connecting the outputs	4
6	OPERATION AND PROGRAMMING	5
7	APPENDIX	6
7.1	Specifications	6
7.1.1	General	6
7.1.2	Power supply	6
7.1.3	Inputs	6
7.1.4	Outputs	7
7.1.5	Electrical connection	7
7.1.6	Electromagnetic compatibility (EMC)	7
7.1.7	Security features	7
7.1.8	Program and data memory	7
7.1.9	Environmental conditions	7
7.1.10	Weight and dimensions	7
7.1.11	Ordering information	7
7.2	Disposal	8
7.3	Conformity declaration	8
7.4	Documents, videos and software	8



1 SAFETY INSTRUCTIONS

This manual contains notices which you should observe to ensure your own personal safety, as well as to protect the product and the connected equipment. These notices are highlighted in the manual by a warning symbol and are marked as follows according to the level of danger:



Only qualified personnel should be allowed to install and work on this equipment. Qualified persons are defined as persons who are authorized to commission, to ground and to tag circuits, equipment and systems in accordance with established safety practices and standards.



Turn off the power supply before performing any wiring operations! Short circuits can be harmful, critical and can cause explosions and serious burns!



Please read this manual carefully and observe all safety instructions!

2 DESTINATED USE

The Mini-PLC STG-600 is designed for universal measuring, controlling and regulating applications. It must not be used for life critical, medical or fail safe applications.

3 DISCLAIMER

BARTH Elektronik GmbH assumes no liability for usage and functionality of the STG-600 in case of disregarding this manual. The strict accordance of this manual is important since the installation methods, peripheral connections, usage and maintenance can not be controlled by BARTH Elektronik GmbH. Therefore BARTH Elektronik GmbH assumes no liability for any claim.

4 PRODUCT DESCRIPTION

This picture below shows the BARTH[®] Mini-PLC STG-600 with additional accessory, included in the STA-600 Starter-Kit (Art. No. 0660-0600). The STG-600 (Art. No. 0850-0600) comes without USB connection cable VK-12 and the 9V battery supply.



4.1 Features

- Small and universal Programmable Logic Controller (PLC)
- 8 analog/digital inputs 0..30 VDC
- 2 digital inputs up to 10 kHz
- 8 power outputs up to 1.5 A
- 1 power PWM output 2 A/0..10 kHz
- Reliable solid-state outputs
- Programmable Status LED
- USB connection to PC
- Intuitive graphical programming capability
- Wide operating voltage range 7..32 VDC
- Wide operating temp. range -40..+60°C
- Ultraflat housing, height only 10 mm
- Vibration resistant and rugged PU sealing
- Very low current consumption

4.2 Applications

- Industrial Automation
- Building Automation
- Automotive Technology
- Agriculture Vehicles
- Maritime Technology
- Environmental Technology
- Light and Show Technology

4.3 General description

The STG-600 is a highly integrated programmable logic controller (PLC) providing outstanding graphical programming capability at lowest current consumption and small form factor.

With its cutting edge features the STG-600 opens up completely new application fields with space restrictions and high integration level requirements.

The STG-600 does not need any peripheral components to operate. Both inputs and outputs features highly integrated and rugged protection circuits to operate the Mini-PLC in harsh environment.

Due to its extremely low current consumption and wide operation voltage range the STG-600 is well suitable for 12 and 24 V battery-powered systems.

These outstanding features open up a variety of application fields in industrial, automotive and maritime technology.

The STG-600 is also available as customer-tailored OEM version.

4.4 Programming with miCon-L

Without learning a difficult programming language the BARTH® Mini-PLC can be easily programmed using simple and vivid graphical function blocks. This block design meets graphical standards of the latest graphical programming languages.

The miCon-L software suite features programming, simulation and test in one unique software design tool. The flexible programming option offers a variety of possibilities in industrial, automotive and maritime applications.

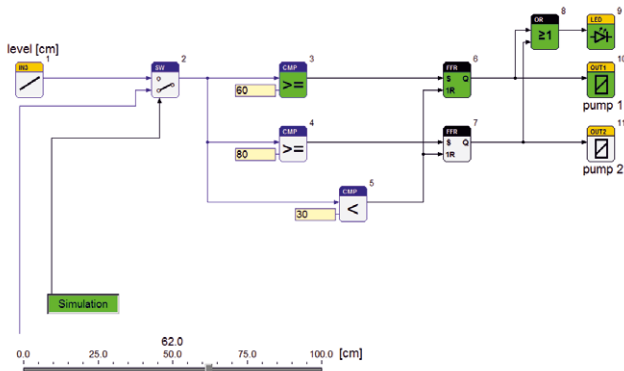

Programming the STG-600 follows using the USB port of your PC with installed miCon-L software suite. miCon-L also supports full simulation and visualisation operation modes.

The software provides a variety of visualisation blocks and interactive elements to control and debug the Mini-PLC.

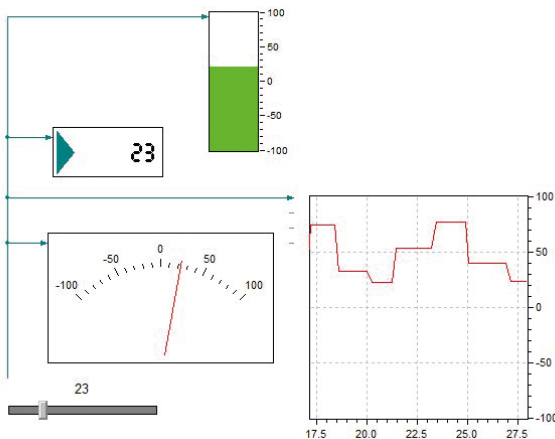

For detailed information please read the BARTH® miCon-L manual and the BARTH® Application Notes on: www.barth-elektronik.de

4.5 Delivery content

- BARTH® Mini-PLC STG-600
- Spring terminal connectors (for supply, input, output)
- Quick start manual

5 INSTALLATION

5.1 Mounting



The STG-600 must be installed and wired by a trained technician who knows and complies with both the universally applicable engineering rules and the regulations and standards that apply in specific cases.

Mounting the STG-600 follows using either the integrated mounting holes for two M4 screws or the four rectangular holes for 3.6mm cable ties. The cable tie installation method is recommended for fastening the STG-600 on a wiring harness, tube or other mechanical part.

Take care to meet the environmental conditions of the STG-600 (chapter 7.1.9).

5.2 Wiring

5.2.1 Connecting the power supply

The STG-600 features an outstanding wide supply voltage range from 7 to 32 VDC at lowest current consumption.

So the Mini-PLC can be integrated within battery supplied 12V or 24V DC systems (cars, trucks, battery powered cars, forklifts and digger, for example).

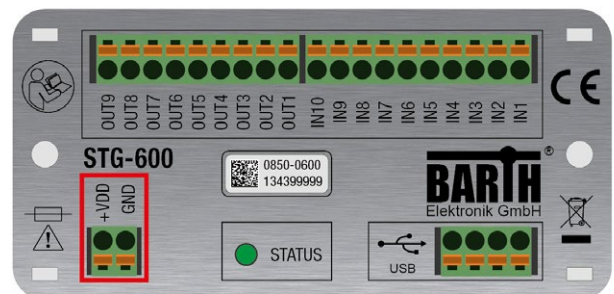

Turn off the power supply before performing any wiring operations!



False electrical connection, voltage reversal or disregarding the electrical specifications may cause irreversible damage of the Mini-PLC!

Connect the supply voltage of 7 to 32 VDC to the 2-pole terminal ,+VDD' and ,GND' of the STG-600 (marked red in the illustration above).

Wire the positive supply to the ,+VDD' marked connector. The negative (ground) will be wired to the ,GND' connector. All terminals are carried out as pluggable spring terminal connectors for a wire gauge of 0.25 to 1.5mm².



Ensure correct power supply voltage range and polarisation! External fusing of 8A max. is mandatory! Disregard may cause irreversible damage of the Mini-PLC!

5.2.2 Connecting the inputs

You can connect sensors, switches or buttons to the inputs. The sensors may be temperature, flow, pressure, photo-electric sensors or proximity switches, for example. The STG-600 is well suitable for any sensor featuring a voltage output, 0 to 10 VDC, for example.

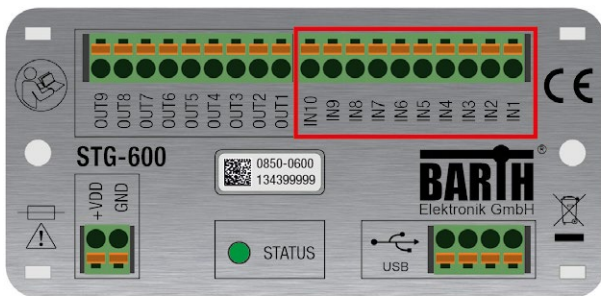

Common features of the inputs

- IN3 to IN10 are selectable analog/digital inputs
- IN1 and IN2 are pure digital inputs (up to 1kHz)
- Wide input voltage range 0 to 32VDC
- IN3 to IN10 are 0 to 10 V compatible
- Comprehensive integrated protection circuits
- Outstanding electromagnetic compatibility (EMC)
- Electrostatic discharge protection (ESD)

Due to the pull-down resistors integrated in the STG-600 any switch (NO/NC) can simply be connected between the positive supply (VDD) of the STG-600 and the desired input.



The voltage at any input must not exceed 32VDC referred to ground (GND). Higher voltages or reverse voltage lower than -32VDC may cause irreversible damage of the Mini-PLC!

The 10-pole connector named ,IN1' to ,IN10' contains all inputs of the Mini-PLC (marked red in the illustration above). While IN1 and IN2 are pure digital inputs, IN3 to IN10 provide both digital or analog functionality.

The voltage range for all inputs may not exceed 32 VDC. All inputs refer to GND. Please refer to chapter 7.1.3 for detailed electrical specification of the inputs.

5.2.3 Connecting the outputs

Depending on load type and current the STG-600 is able to drive electric loads directly without any additional driver or protection circuit. The Mini-PLC provides 8 digital solid-state highside outputs and 1 solid-state lowside switch.

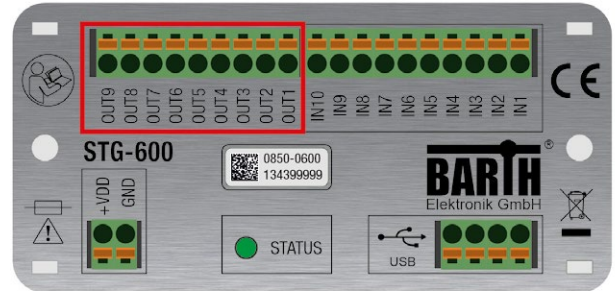

Common features of outputs OUT1 to OUT8

- Rugged solid-state highside switch up to 1.5A
- Paralleling permissible up to 6A
- Short circuit protection and current limitation
- Fast demagnetization of inductive loads
- Stable behaviour at undervoltage
- Comprehensive integrated protection circuits
- Outstanding electromagnetic compatibility (EMC)
- Electrostatic discharge protection (ESD)

Features of output OUT9

- Solid state lowside switch with PWM capability
- Sinks up to 2A
- Rugged solid-state design
- Fast demagnetization of inductive loads
- Outstanding electromagnetic compatibility (EMC)
- Electrostatic discharge protection (ESD)

The 9-pole connector ,OUT1' to ,OUT9' contains all digital outputs of the Mini-PLC (marked red in the illustration above). While OUT1 to OUT8 are overload-protected highside switches, OUT9 is carried out as lowside switch with PWM capability without short circuit protection. A logical HIGH within miConL will switch the Mini-PLC's supply voltage at OUT1 to OUT8, while OUT9 switches lowside (GND). Avoid a sink current exceeding 2A at OUT9 because this outputs is not protected against short-circuiting or overload current !



The total current sourced by OUT1 to OUT8 must not exceed 6A! Avoid reverse voltage at any output higher than the Mini-PLC's supply voltage! OUT9 provides NO short circuit protection. Take care the sink current not exceeds 2A! Negligence may cause irreversible damage of the Mini-PLC!

6 OPERATION AND PROGRAMMING

To operate the STG-600 first establish proper power supply connection at both +VDD and GND terminals (see chapter 5.2.1).

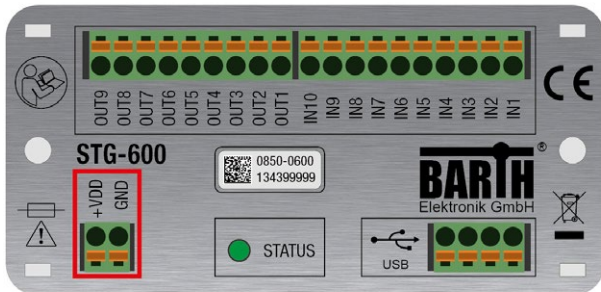

For programming and PC connection the connection cable VK-12 (Art. No. 0091-0012) and a PC with installed Windows operating system are mandatory.



Before you connect the Mini-PLC to the PC you have to install the USB-/COM-port driver (folder ,USBdriver') from the software download package:

www.barth-elektronik.de/download/9045-0008-A.zip

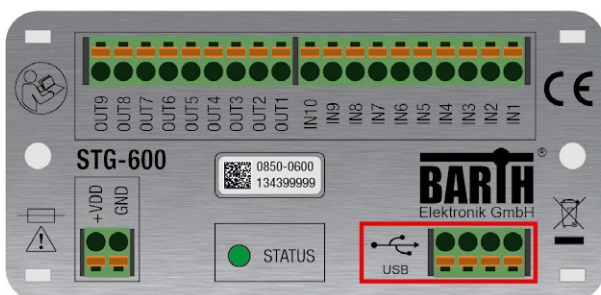

Now install the miConL software suite from the ,miCon-L' folder. Follow the setup instructions of miConL. Afterwards establish the PC connection using the VK-12 connection cable and run miConL.

For choosing the correct COM-Port please click the right button (configure serial interface) located on the main menu page and confirm the added COM-Port used by the STG-600.

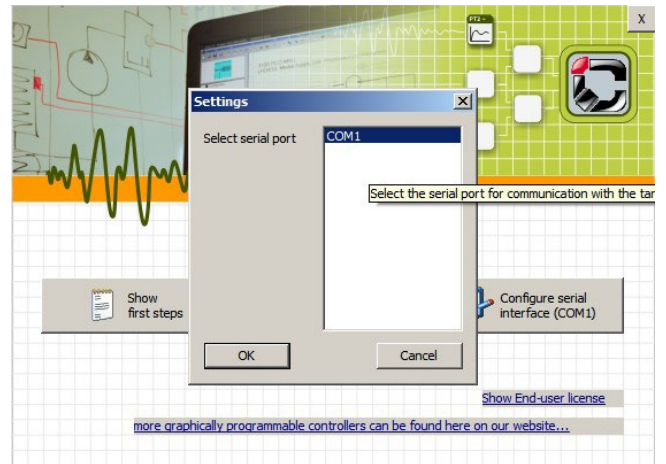

Now start miConL with creating a new project (Project->New) or open a miCon-L sample application (Project->Open).

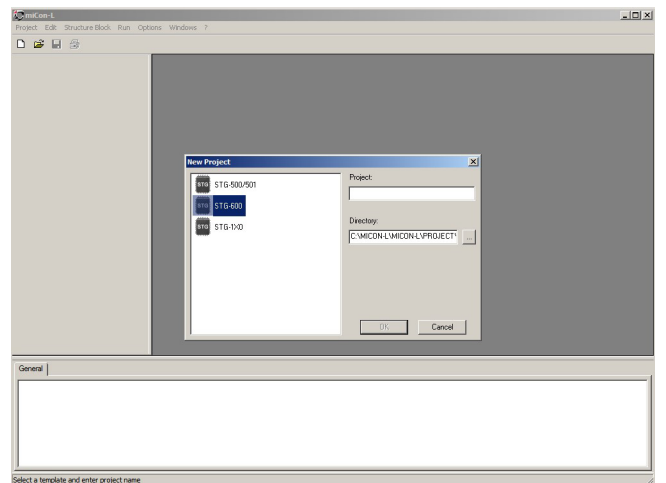

Creating a new project the desired Mini-PLC model and the project name have to be defined.

After opening or creating a project the workspace of miConL with it's libraries (right) is shown.

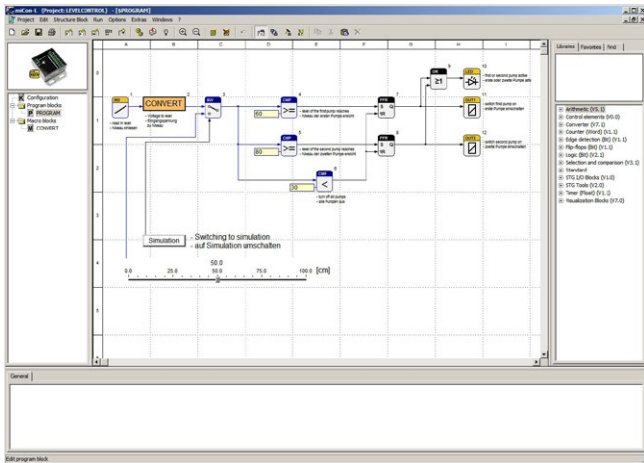

Additional help and a detailed user manual is provided within the miCon-L help and the miConL context menu (right mouse button).

7 APPENDIX

7.1 Specifications

7.1.1 General

Hardware design	BARTH® Mini-PLC fully enclosed in proprietary PU resin, super-flat and rugged housing with pluggable spring terminal connectors, ultra-light-weight
Programming	miCon-L Software, graphical (function block style), simulation, programming and visualisation, free license model
Interfaces	USB reserved for miCon-L software communication

7.1.2 Power supply

Operating voltage	7 to 32 VDC
Current consumption	< 4 mA at 32 VDC status LED switched off in application
Fusing	8 A max. (external) mandatory for voltage reversal protection
Voltage reversal protection	yes (combined with external fuse)
ESD/TVS protection	yes
Heat dissipation (at full load)	normally < 2 W

7.1.3 Inputs

Number digital	2+8
Number analog	8
Digital input IN1 - IN2	$U_{IN} = 0..30$ VDC $R_{IN} > 30$ kOhm $U_{LOW} \leq 2$ VDC $U_{HIGH} > 4$ VDC $f_{IN} \leq 1$ kHz $t_{IN} \geq 1$ ms
Analog input IN3 - IN10	$U_{IN} = 0..30$ VDC $R_{IN} > 11$ kOhm $f_{IN} \leq 100$ Hz $t_{IN} \geq 10$ ms
Accuracy ADC IN3 - IN10	$\pm 3\%$ (0.5 VDC)
ADC resolution (internal)	10 Bit
Potential isolation	no (common GND)
ESD/TVS protection	yes
Permissible cable lenght (per input)	normally 40 m

7.1.4 Outputs

Number digital	8+1
Number PWM	1
Output OUT1 - OUT8	Output type: solid state $I_{OUT} \leq 1,5 \text{ A}$ (resistive load) @ $f_{OUT} = 0..100 \text{ Hz}$ $U_{OUT} \geq U_{IN} - 0,45 \text{ V}$ $I_{TOT} \leq 6 \text{ A}$ (paralleling permissible) Maximal allowable load inductance for a single switch off (one output): $V_{DD} = 12\text{VDC}$, $I_L = 1.5\text{A}$, $Z_L \leq 70\text{mH}$ $V_{DD} = 12\text{VDC}$, $I_L = 1\text{A}$, $Z_L \leq 200\text{mH}$ On-state resistance V_{DD} to OUT: $R_{ON} \leq 180\text{mOhm}$ Turn-on time: $t_{ON} \leq 250\mu\text{s}$ Turn-off time: $t_{OFF} \leq 270\mu\text{s}$
PWM output OUT9	Output type: solid state $I_{OUT} \leq 2 \text{ A}$ (resistive load) @ $f_{OUT} = 0..100 \text{ Hz}$ $I_{OUT} \leq 1 \text{ A}$ (resistive load) @ $f_{OUT} = 100 \text{ Hz}..5 \text{ kHz}$ $U_{OUT} \leq \text{GND} + 0,25 \text{ V}$
Potential isolation	no

7.1.5 Electrical connection

Electrical Connection	pluggable spring terminal connectors 0.25 to 1.5 mm ²
------------------------------	--

7.1.6 Electromagnetic compatibility (EMC)

Electrostatic discharge (ESD) on IN1 to IN10	20 kV air discharge 30 kV contact discharge (IEC/EN 61 000-4-2, level 3)
Electrostatic discharge (ESD) on OUT1 to OUT9	8 kV (human body model) (MIL-STD883D)
Electromagnetic fields	Field strength 10 V/m (IEC/EN 61000-4-3)

7.1.7 Security features

Security Features	Watchdog (WD) Brown out detection (BOD) Power up timer (PUT)
--------------------------	--

7.1.8 Program and data memory

Flash program memory	64 k cell endurance: 10.000 min characteristic retention: 40 yrs
EEPROM data memory	1024 byte byte endurance 100.000 min. characteristic retention: 40 yrs

7.1.9 Environmental conditions

Operation temperature	-40..+60 °C (IEC 60068-2-1/2)
Storage temperature	-40..+70 °C (IEC 60068-2-1/2)
Relative humidity	5 to 95% non-condensing (IEC 60068-2-30)
Air pressure (in operation)	500 to 1500 hPa
Shock resistance	min. 100 m/s ² (IEC 60068-2-27)
Vibration resistance	min. 50 m/s ² @ 10..150 Hz (IEC 60068-2-6)
Degree of protection	IP 20, limited by connectors (EN 50178, IEC 60529)
Drop	Drop height: 500mm (IEC 60068-2-31)
Free fall (packaged)	1500 mm (IEC 60068-2-32)

7.1.10 Weight and dimensions

Weight	80 g (without connectors)
Dimensions	93 x 45 x 15 mm (LxWxH) Height housing: 10 mm
Mounting	via two M4 screws or 3.6mm cable ties

7.1.11 Ordering information

Ordering information Mini-PLC	Mini-PLC STG-600 Art. No. 0850-0600
Ordering information Starter-Kit	Starter-Kit STA-600 Art. No. 0660-0600
Ordering information accessory	USB connection cable VK-12 Art. No. 0091-0012

7.2 Disposal



If you wish to finally dispose of the product, ask your local recycling centre or dealer for details about how to do this in accordance with the applicable disposal regulations.

7.3 Conformity declaration

For the following designated product it is hereby confirmed, that the construction in that technical design brought by us in traffic corresponds to the standards specified below. In the event of any alternation which has not been approved by us being made to any device as designated below, this statement shall thereby be made invalid.

Description	Mini-PLC
Type	STG-600
Art. No.	0850-0600
Directive 2004/108/EG relating to electromagnetic compatibility (EMC) 	Applied norms: EN55022:2006+A1:2007 EN55024:1998+A1:2001 +A2:2003 EN61000-3-2:2006 +A1:2009+A2:2009 EN61000-3-3:2008 EN61000-6-2:2005
RoHS Directive 2011/65EU	We hereby declare that our product is compliant to the RoHS Directive on restriction of the use of certain hazardous substances in electrical and electronic appliances.

BARTH® Elektronik GmbH

Lengerich, 10.10.2013



Dipl.-Ing. (FH) D. Barth
Managing Director

7.4 Documents, videos and software

Detailed information, additional documents, application notes and videos relating to this product are downloadable from www.barth-elektronik.de