

lococube®
mini-PLC STG-800/810/820

MANUAL

TABLE OF CONTENT

SAFETY INSTRUCTIONS 1

DESTINATED USE 1

DISCLAIMER 1

EYE SAFETY INFORMATION 1

1 Product Features 2

2 Get Started 2

2.1 Mounting 2

2.2 Wiring 2

2.2.2 Connecting the power supply 3

2.2.3 Connecting the inputs 3

2.2.4 Connecting the outputs 3

2.2.5 Connecting the CAN interface 4

3 Get running 4

3.1 Programming Software 4

3.2 Programming Service 5

3.3 Programming Interface 5

3.4 IrDA interface 5

4 Get Support 5

5 Appendix 6

5.1 Specifications 6

5.1.1 General 6

5.1.2 Power supply 6

5.1.3 Inputs 6

5.1.4 Outputs 6

5.1.5 Interfaces 6

5.1.6 Security features 6

5.1.7 Program and data memory 6

5.1.8 Timebase (oscillator) 7

5.1.9 Electrical connection 7

5.1.10 Electromagnetic compatibility (EMC) 7

5.1.11 Environmental conditions 7

5.1.12 Weight and dimensions 7

5.1.13 MTTF and MTTFd 7

5.1.14 Certifications & Approvals 7

5.1.15 Ordering information 8

5.2 Disposal 8

5.3 Conformity declaration 8

SAFETY INSTRUCTIONS

This manual contains notices which you should observe to ensure your own personal safety, as well as to protect the product and the connected equipment. These notices are highlighted in the manual by a warning symbol and are marked as follows according to the level of danger:



Only qualified personnel should be allowed to install and work on this equipment. Qualified persons are defined as persons who are authorized to commission, to ground and to tag circuits, equipment and systems in accordance with established safety practices and standards.



Turn off the power supply before performing any wiring operations! Short circuits can be harmful, critical and can cause explosions and serious burns!



Please read this manual carefully and observe all safety instructions!

DESTINATED USE

The lococube® is designed for universal measuring, controlling and regulating applications.

DISCLAIMER

BARTH® assumes no liability for usage and functionality of the lococube® when disregarding the safety guidelines in this manual. The strict accordance of the guidelines is important since the installation methods, peripheral connections, usage and maintenance can not be controlled by BARTH®. Therefore BARTH® assumes no liability for any claim.

EYE SAFETY INFORMATION

Only applicable to STG-810/820:

Standard	Classification
IEC/EN 60825-1 (2007-03), DIN EN 60825-1 (2008-05) "SAFETY OF LASER PRODUCTS - Part 1: equipment classification and requirements", simplified method	Class 1
IEC 62471 (2006), CIE S009 (2002) „Photobiological Safety of Lamps and Lamp Systems“	Exempt
DIRECTIVE 2006/25/EC OF THE EUROPEAN PARLIAMENT AND OF THE COUNCIL of 5th April 2006 on the minimum health and safety requirements regarding the exposure of workers to risks arising from physical agents (artificial optical radiation) (19th individual directive within the meaning of article 16(1) of directive 89/391/EEC)	Exempt

1 Product Features

- High-Performance 32 Bit ARM® Cortex®
- 3 analog Inputs 0 to 30 VDC, 12 Bit ADC
- Event Counter Input 25 kHz
- Pulse and Frequency Counter Input 40µs
- 4 Solid-State Power Outputs up to 1.5 A
- 1 Power PWM Output 16 Bit 1 Hz to 25 kHz (STG-800/810)
- 1 analog Output 0 to 5V up to 100kHz (STG-820)
- CAN 2.0A/B and SAE J1939 Interface
- CANopen® Interface (Open Source)
- Comprehensive Fail Safe Functions
- Programmable Status LED
- IrDA/SIR Interface (STG-810/820)
- TTL-232 3.3V Interface
- Intuitive Graphical Programming Capability
- Open Source Programming
- Wide Operating Voltage Range 7 to 32 VDC
- Wide Operating Temp. Range -40 to +70°C
- Vibration Resistant and Rugged Sealing
- CE, UKCA, UL und ECE-R10 certified
- Engineered and Manufactured in Germany
- Dimensions (LxWxH): 60x45x15mm
- Weight: 50g

2 Get Started

2.1 Mounting



The lococube® is intended to be mounted in enclosed cabinets and the like, that afford protection against fire hazards, environmental conditions and mechanical impact.

1



Screw mounting:

Easily fasten your lococube with two screws.

You need:

Two screws M4 or selftapping screws 3.9mm.

2

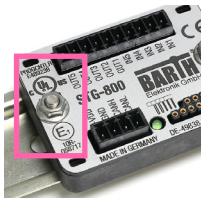

DIN Rail mounting:

Fasten your lococube in a cabinet housing.

You need:

[DIN Rail Bracket HA-30](#)

3



Self-adhesive pad mounting:

Quickly fasten your lococube® on a plain surface.

You need:

Self-adhesive tape

4

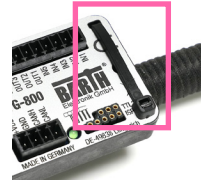

Cable tie mounting

Quickly fasten your lococube® on a wiring harness or tube.

You need

Two 3.6mm cable ties

2.2 Wiring

2.2.1 Overview

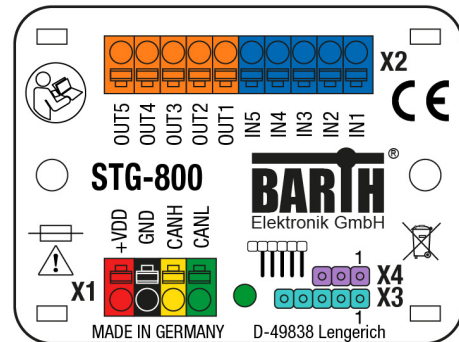

X1 connector: supply and CAN pins

1		+VDD	Positive Supply Voltage (fused!)	
2		GND	Ground	
3		CANH	CAN High	
4		CANL	CAN Low	

add termination resistor 2x120R

X2 connector: inputs and outputs

1		IN1	Input 0-30VDC	Analog/Digital
2		IN2		
3		IN3		
4		IN4		
5		IN5		
6		OUT1	Output Digital	Highside 1.5 A
7		OUT2		
8		OUT3		
9		OUT4		
10		OUT5	Output	STG-800/810: lowside/PWM 2 A
				STG-820: 0-5 VDC analog 20 mA/100 kHz

X3 connector: Open Source ISP (via VK-35)

1		+3V3	Positive Power Supply (Pin 1)
2		GND	Ground
3		SYS_SWDIO	System Data IO
4		SYS_SWCLK	System Clock
5		SYS_RESETN	System Reset (inverted)

X4 connector: TTL232 interface (via VK-16)

1	GND	Ground
2	TX	3V3 TTL TX
3	RX	3V3 TTL RX

2.2.2 Connecting the power supply

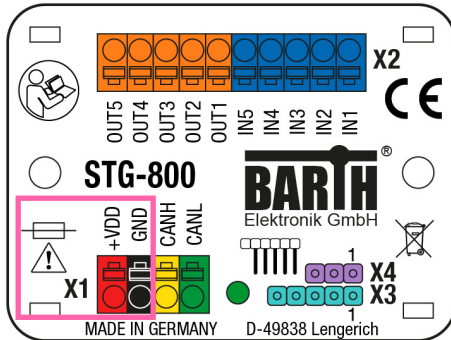

The lococube® features a wide supply voltage range from 7 to 32 VDC at lowest current consumption. The lococube® can be integrated within battery supplied 12V or 24V DC systems (cars, trucks, battery powered cars, forklifts and digger, for example).



Turn off the power supply before performing any wiring operations!



Wrong electrical connection, voltage reversal or disregarding the electrical specifications may cause irreversible damage to the lococube®!

Connect the supply voltage of 7 to 32 VDC to the 4-pole terminal X1 on the lococube®. Wire the positive supply to the '+VDD' marked connection. The negative (ground) will be wired to the 'GND' connection. All terminals are carried out as plugable spring terminal connectors for a wire gauge of 0.25 to 1.5mm².



**Ensure correct power supply voltage range and polarisation!
External fusing of 5A max. is mandatory!
Disregarding may cause irreversible damage of the lococube®!**

2.2.3 Connecting the inputs

You can connect sensors, switches or buttons to the inputs of your lococube®. The sensors may be temperature, flow, pressure, photoelectric sensors or proximity switches, for example.

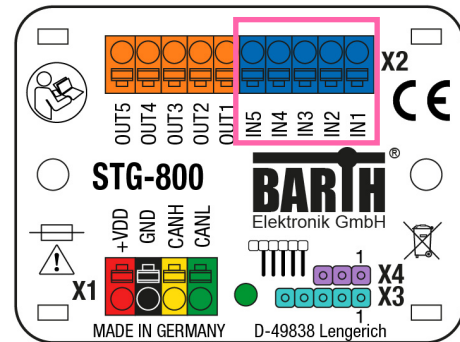

Due to the pull-down resistors integrated in the lococube® any switch (NO/NC) can simply be connected between the positive supply (+VDD) and the desired input. The 10-pole connector named X2 contains the inputs of the lococube®. While IN4 and IN5 are pure digital inputs, IN1 to IN3 provide both digital or analog (0-30V) functionality. The voltage range for all inputs may not exceed 32 VDC. All inputs refer to GND.



**The voltage at any input must not exceed 32 VDC referred to ground (GND).
Higher voltages or reverse voltage lower than -32 VDC may cause irreversible damage of the lococube®!**

2.2.4 Connecting the outputs

Depending on load type and current the lococube® is able to drive electric loads directly without any additional driver or protection circuit. The lococube® provides 4 digital solid-state highside outputs and 1 solid-state lowside switch.

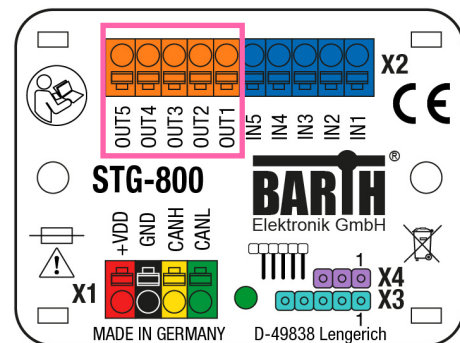

The 10-pole connector X2 contains the digital outputs of the lococube®. While OUT1 to OUT4 are overload protected highside switches, OUT5 is carried out as lowside switch with PWM capability without short circuit protection (STG-800/810). A logical HIGH within miCon-L will switch the lococube®'s supply voltage at OUT1 to OUT4, while OUT5 switches lowside (GND). The STG-820's OUT5 is carried out as analog 0 to 5 VDC output with integrated short circuit protection (20 mA). It can be switched up to 100 kHz within the 0 to 5 VDC analog voltage range.



The total current sourced by OUT1 to OUT4 must not exceed 4 A!
Avoid reverse voltage at any output higher than the lococube®'s supply voltage! OUT5 (STG-800/810) provides NO short circuit protection. Take care the sink current not exceeds 2 A! Negligence may cause irreversible damage of the lococube®!
If you use open source programming take care of not switching OUT1 to OUT4 higher than 100 Hz!
Rise and fall times of the output driver IC will cause higher power-losses resulting in heat dissipation.

2.2.5 Connecting the CAN interface

The X1 connector of the lococube® contains the CAN-specific pins ,CANH' and ,CANL'.

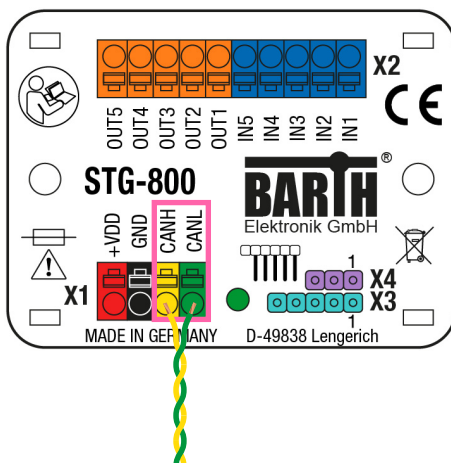

There is no termination resistor integrated in the lococube®. Please add a 120R resistor at both ends (2) for correct CAN bus termination.



The voltage at CANH or CANL must not exceed -32 or +32 VDC referred to ground (GND). Higher voltages may cause irreversible damage of the lococube®!

3 Get running

3.1 Programming Software

There are two options to program your lococube®:

1



Graphical Programming

Fast, easy and intuitive programming by connecting function blocks on a worksheet.

Ideal for:

People starting out and projects with shortest possible time-to-market.

You need:

[mini-PLC STG-800](#)
[mini-PLC STG-810](#)
[mini-PLC STG-820](#)
[Connection Cable VK-16](#)
OR
[Connection Cable VK-46](#)

Software:

[miCon-L IDE](#)

2



C Programming

Structured C style within KEIL® MDK or STM32CubeIDE®.

Ideal for:

Realizing extensive, complex, and time critical applications.

You need:

[mini-PLC STG-800](#)
[mini-PLC STG-810](#)
[mini-PLC STG-820](#)
[Connection Cable VK-46](#)

Software:

[KEIL MDK](#)
[STM32CubeIDE](#)

3.2 Programming Service

1

Programming Service Open Source

Convenient Service for all lococube® products to be programmed in ,C'.

Ideal for
Businesses that want to commission programming services.

Contact
jasys GmbH & Co. KG
An der Nordbahn 19
D-16556 Hohen Neuendorf
GERMANY
Phone: +49 (0)3303 212166
Mail: info@jasys.de

2

Programming Service miCon-L

Convenient graphical Programming Service for all lococube® products supporting miCon-L.

Ideal for
Businesses that want to commission programming services.

Contact
ProSign GmbH
Werner-Heisenberg-Straße 1
D-39106 Magdeburg
GERMANY
Phone: +49 (0)391 563068-90
Mail: info@pro-sign.de

3.3 Programming Interface

Both X3 and X4 connectors ensure programming of the lococube®. For graphical miCon-L programming the X4 connector is reserved for application communication via the Connection Cable VK-16 (BARTH® Art. No. 0091-0016) or VK-20 (BARTH® Art. No. 0091-0020).

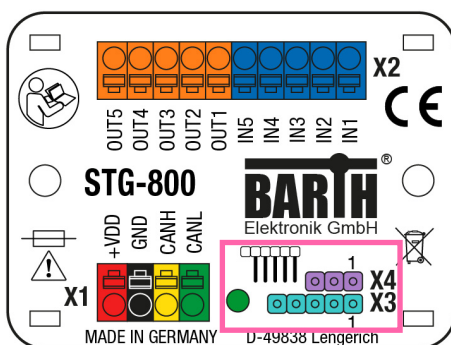

If you choose the Open Source Programming Option, use the X3 connector for programming and debugging via the Connection Cable VK-35 (BARTH® Art. No. 0091-0035). In this case the X4 connector can be used as TTL232 UART interface within your application.

3.4 IrDA interface

The STG-810/820 feature an IrDA (SIR) interface which bases on infrared light technology to transfer serial data. This interface can be used in combination with the BARTH® PG-65 Parameter programmer (BARTH® Art. No. 0017-0065) to communicate user-defined parameters.



i The IrDA Interface will not be supported using the graphical programming with miCon-L.

4 Get Support

i Technical support is available on: <https://support.barth-elektronik.com>

5 Appendix

5.1 Specifications

5.1.1 General

Hardware design	BARTH® lococube® mini-PLC fully enclosed in proprietary PU resin, tiny and rugged housing with pluggable spring terminal connectors, ultra-lightweight
Programming options	miCon-L Software, graphical (function block style), simulation, CAN programming and visualisation, free license Open Source, C-Programming
Interfaces	UART TTL232 (3.3V TTL level) USB (VK-16 or VK-20 required) reserved for miCon-L software communication or USB/COM CAN 2.0A/B/open®/SAE J1939 NMEA2000 (open source)

5.1.2 Power supply

Operating voltage	7 to 32 VDC
Current consumption	nominal 10 mA at 32 VDC (depending on configuration)
Fusing	5 A max. (external) mandatory for voltage reversal protection
Voltage reversal protection	yes (combined with external fuse)
ESD/TVS protection	yes, integrated
Heat dissipation air	normally < 2 W (full load)

5.1.3 Inputs

Number digital	2+3
Number analog	3
Analog / digital input IN1 - IN3	$U_{IN} = 0$ to 30 VDC $R_{IN} > 11$ kOhm $f_{IN} \leq 1$ kHz $t_{IN} \geq 1$ ms
Digital / counter input IN4 - IN5	$U_{IN} = 0..30$ VDC $R_{IN} > 20$ kOhm $U_{LOW} < 3$ VDC $U_{HIGH} > 5$ VDC $f_{IN} \leq 25$ kHz $t_{IN} \geq 40$ μ s
Accuracy ADC (IN1 - IN3)	<0.15 VDC
ADC resolution (internal)	12 Bit
Potential isolation	no (common GND)
ESD/TVS protection	yes

5.1.4 Outputs

Number digital	4+1
Number PWM	1 (STG-800/810)
Number analog	1 (STG-820)
Output OUT1 - OUT4	Output type: solid state (highside) $I_{OUT} \leq 1.5$ A (resistive load) @ $f_{OUT} = 0$ to 100 Hz $U_{OUT} \geq U_{IN} - 0.45$ V $I_{TOT} \leq 4$ A (paralleling permissible) Maximal allowable load inductance for a single switch off (one output): $V_{DD} = 12$ VDC, $I_L = 1.5$ A, $Z_L \leq 70$ mH $V_{DD} = 12$ VDC, $I_L = 1$ A, $Z_L \leq 200$ mH On-state resistance V_{DD} to OUT: $R_{ON} \leq 180$ mOhm Turn-on time: $t_{ON} \leq 250$ μ s Turn-off time: $t_{OFF} \leq 270$ μ s
PWM output OUT5 (STG-800/810)	Output type: solid state (lowside) $I_{OUT} \leq 2$ A (resistive load) @ $f_{OUT} = DC$ to 25 kHz $I_{OUT} \leq 1$ A (inductive load)
Analog output OUT5 (STG-820)	0 to 5 VDC analog output $I_{OUT} \leq 20$ mA (resistive load) @ $f_{OUT} = DC$ to 100 kHz
Potential isolation	no

5.1.5 Interfaces

CAN	CAN 2.0A/B: 11/29 bit ID, base frame format Baud rates: 50, 100, 125, 250, 500 kbit, 1Mbit CANopen® (Open Source) multi line, single line, master, slave SAE J1939 (Open Source) NMEA 2000 (Open Source) Meets or exceeds the requirements of applications ISO 11898-2, loss of ground protection from -32 V to +32 V, thermal shutdown protection
TTL232	3.3V TTL level, config: 8N1 Baud rates: 2400 to 115.2 kbit/s
IrDA (infrared) (STG-810/820)	SIR (9.6 kbit/s to 115.2 kbit/s) IrPHY (for PG-65 communication) range: 0-300mm

5.1.6 Security features

Security Features	System and independent WD Fail safe oscillator Power on/down reset Supply voltage supervisor
--------------------------	---

5.1.7 Program and data memory

Memory	Flash program memory: 256 kB SRAM: 32 kB EEPROM: 8kB, >1M write cycles
---------------	--

5.1.8 Timebase (oscillator)

Primary Oscillator	Crystal quartz MEMS unit (precise ,micro-electro-mechanical system')
Nominal Frequency	16.000 MHz
Frequency tolerance	$\pm 50 \times 10^{-6}$
Frequency aging	$\pm 5 \times 10^{-6}$ / year max.

5.1.9 Electrical connection

Electrical Connection	pluggable spring terminal connectors 0.25 to 1.5 mm ² Manufacturer: Phoenix Contact Series: COMBICON Type: FMC1,5/x-ST-3,5-BK
------------------------------	---

5.1.10 Electromagnetic compatibility (EMC)

Electrostatic discharge (ESD) on IN1 to IN5	20 kV air discharge 30 kV contact discharge (IEC/EN 61 000-4-2, level 3)
Electrostatic discharge (ESD) on OUT1 to OUT5	8 kV (human body model) (MIL-STD883D)
Electromagnetic fields	Field strength 10 V/m (IEC/EN 61000-4-3)
CAN bus terminals (CANH, CANL to GND)	IEC 61000-4-2: Unpowered Contact Discharge ±15000 V
	IEC 61000-4-2: Powered Contact Discharge ±8000 V

5.1.11 Environmental conditions

Operation temperature	-40 to +70 °C (IEC 60068-2-1/2)
Storage temperature	-40 to +70 °C (IEC 60068-2-1/2)
Relative humidity	5 to 95% non-condensing (IEC 60068-2-30)
Air pressure (in operation)	500 to 1500 hPa
Shock resistance	min. 300 m/s ² (IEC 60068-2-27)
Vibration resistance	min. 80 m/s ² @ 10..100 Hz (IEC 60068-2-6)
Degree of protection	IP 20 (not evaluated by UL) (EN 50178, IEC 60529)
Drop	Drop height: 1000 mm (IEC 60068-2-31)
Free fall (packaged)	1500 mm (IEC 60068-2-32)





5.1.12 Weight and dimensions

Weight	50 g (without connectors)
Dimensions	60 x 45 x 15 mm (LxWxH)
Mounting	via two M4 screws or 3.6mm cable ties

5.1.13 MTTF and MTTFd

Calculation basis	DIN EN ISO 13849-1:2008 (@T=25°C)
Calculation formula	DIN EN ISO 13849-1:2008 Annex C.5: MTTF, MTTFd data of electrical components (typical and worst case) D.1: Parts count method (worst case with safety factor 10) $MTTF = \frac{1}{\sum_1^n \frac{1}{MTTF_n}}$ $MTTFd = MTTF \cdot 2$ $MTTFd = \frac{MTTF \cdot 2}{10}$ (worst case)
MTTF [years]	195
MTTFd [years]	390
MTTFd worst case [years]	39
Explanation	This information is given without any guarantee. The indicated product is no safety component according to the machine directive 2006/42/EC (subject to modifications).

5.1.14 Certifications & Approvals

	2004/108/EG 2004/108/EC 2014/30/EU
	File No. E489238 UL 61010-1, 3rd Edition, May 11, 2012, Revised April 29 2016, CAN/CSA-C22.2 No. 61010-1-12, 3rd Edition, Revision dated April 2016
	File No. E489238 UL 61010-2-201 Ed.1 January 24, 2014, Revision dated February 20, 2017 CAN/CSA C22.2 No. 61010-2-201:14 Ed.1, February 2014
	CANopen® Vendor ID: 46Ah
	Cert. No. E1-10R-058717 ECE R 10, Rev. 5 (for nominal 12V automotive applications)

5.1.15 Ordering information

Ordering information lococube® mini-PLC	lococube® mini-PLC STG-800 Art. No. 0850-0800 GTIN 4251329401207
	lococube® mini-PLC STG-810 Art. No. 0850-0810 GTIN 4251329401320
	lococube® mini-PLC STG-820 Art. No. 0850-0820 GTIN 4251329401382
Ordering information lococube® accessory	Connection Cable VK-16 (graphical programming) Art. No. 0091-0016 GTIN 4251329400187
	Connection Cable VK-46 (Open source & graphical programming) Art. No. 0091-0046 GTIN 4251329406226

	BARTH Elektronik GmbH declares conformity of the product for which this manual is intended with the UKCA equivalents of the aforementioned CE regulations. We therefore deem the product to be in full compliance with UKCA regulations and take full legal responsibility for it. This declaration was issued on 30.11.2021
---	---

BARTH® Elektronik GmbH
Lengerich, 01.04.2025



Dipl.-Ing. (FH) D. Barth, CEO

5.2 Disposal

	<p>If you wish to finally dispose of the product, ask your local recycling centre or dealer for details about how to do this in accordance with the applicable disposal regulations.</p>
--	---

5.3 Conformity declaration

For the following designated product it is hereby confirmed, that the construction in that technical design brought by us in traffic corresponds to the standards specified below. In the event of any alternation which has not been approved by us being made to any device as designated below, this statement shall thereby be made invalid.

Description	lococube® mini-PLC
Type / Art. No.	STG-800/810/820
Directive CE 2004/108/EG relating to- electromagnetic compatibility (EMC) 	Applied norms: 2004/108/EG 2004/108/EC 2014/30/EU
RoHS Directive 2011/65EU	We hereby declare that our product is compliant to the RoHS Directive on restriction of the use of certain hazardous substances in electrical and electronic appliances.